



RDS™ Radially Divided Seals



- MINIMUM PARTS TO ASSEMBLE
- PATENTED ASSEMBLED SPRING RETAINER
- EXTERNAL, VISIBLE, INDICATOR OF CORRECT INSTALLATION
- BALANCED STATIONARY DESIGN WITH LARGE INTERNAL CLEARANCES
- UNIQUE 'O' RING DESIGN

RDS™ - Radially Divided Seal

The AESSEAL® RDS™ (Radially Divided Seal) took five man years of development work to perfect. This radially divided seal has been designed to be the fastest two-part seal to install in the market place.

Significant product development and dynamic testing were aimed at ensuring that the operating performance of the RDS™ seal would be predictable.

The RDS™ seal represents a significant advancement in separation technology and bridges the gap between pump packing and conventional mechanical seals.

Radially Divided Seal

For convenience of manufacture and to reduce costs, most competitive, inventoried, split mechanical seals have rotary and stationary faces which have been cracked, rather than precision-machined and lapped.

The cracking of seal faces can be controlled and can be reasonably predictable, but the potential exists for a leak-path across the split stationary halves, as well as the split rotary halves. The RDS™, radially divided seal, has eliminated one potential leak-path by producing the rotary member as a precision lapped, not cracked, two-part rotary seal. Leakage control on the RDS™ rotary, which has been lapped to the same standards as a normal rotary seal face, is potentially more predictable than from the controlled cracked faces used in other designs.

The RDS™ radially divided rotary has the secondary benefit of avoiding the need for additional sealing 'O' rings and gasket sealing devices.

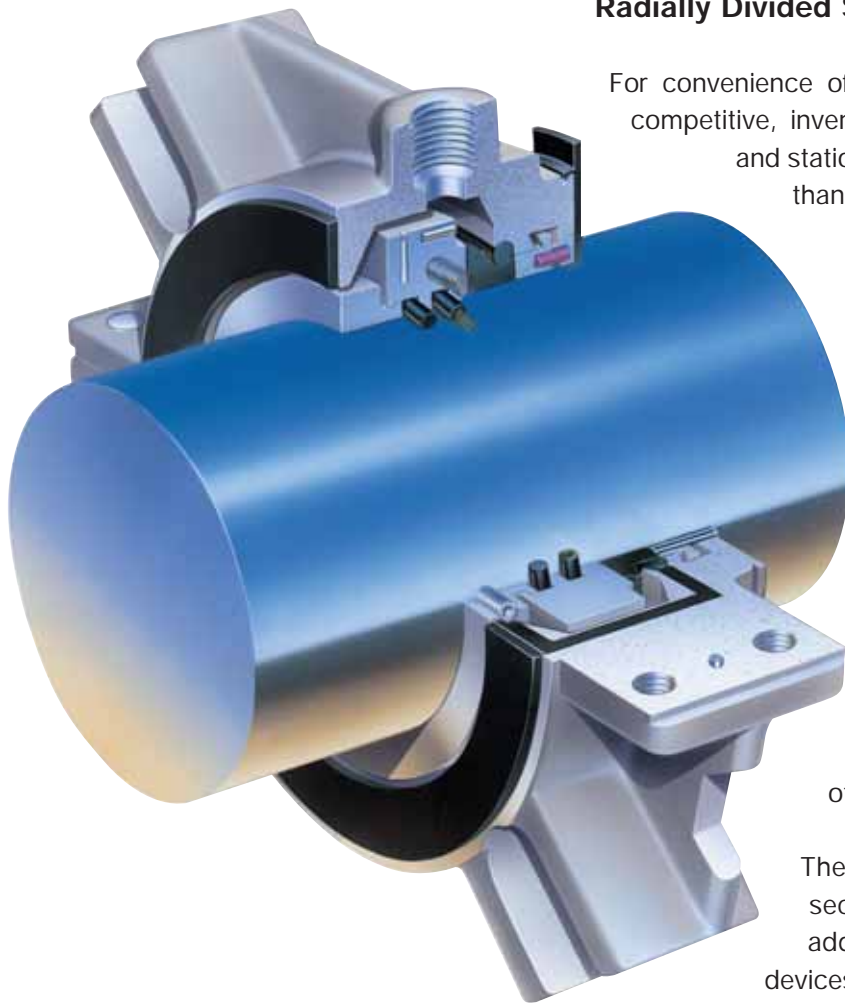

Large Cross Section

Many RDS™, radially divided seals, will be used to replace stuffing box packing. Often the shaft or sleeve will be heavily scored by the packing, particularly on larger diameters.

A possible option might be to remove the sleeve entirely, or reduce the outside diameter of the sleeve or shaft to provide a good surface to seal the RDS™ on.

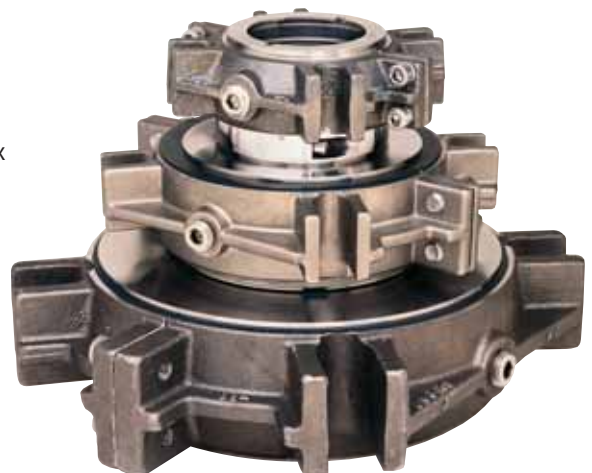

RDS™ - Radially Divided Seal



All RDS™ seals are guaranteed not to fret the shaft or sleeve, following installation. This means that it might be practical to remove the shaft sleeve entirely, as long as it is not designed to set or position the impeller clearance.

With other designs, i.e. split seals, this option might not be available without manufacturing an adaptor plate, to seal the larger cross section that would result from reducing the shaft or sleeve outside diameter size.

Such an adaptor plate would have to be split, normally, with gaskets between the two adaptor halves. There would also have to be a split gasket sealing against the stuffing box face.

Naturally, the more potential leakage paths the less chance of predictable trouble-free sealing.

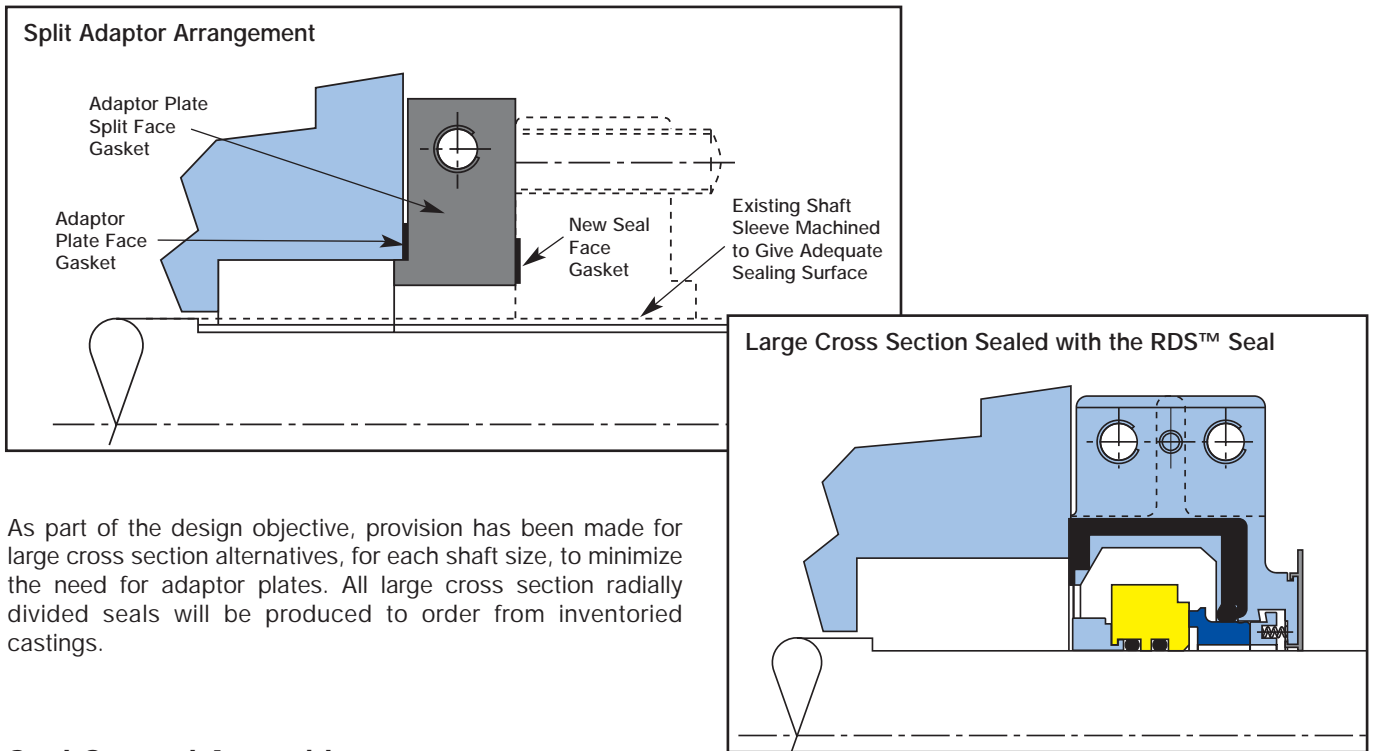

As part of the design objective, provision has been made for large cross section alternatives, for each shaft size, to minimize the need for adaptor plates. All large cross section radially divided seals will be produced to order from inventoried castings.

Seal General Assembly

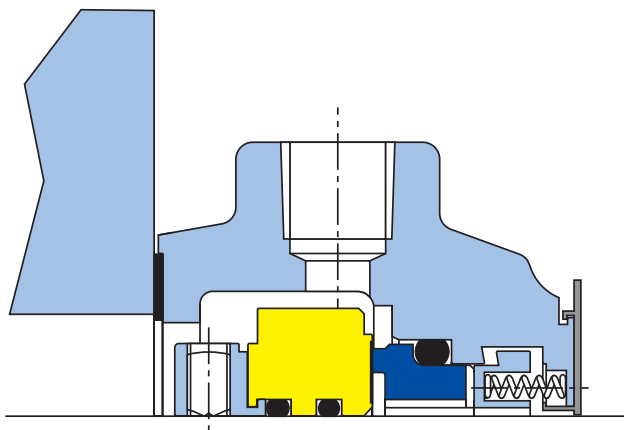

Stationary Seal

The RDS™ seal is a stationary seal. In a stationary seal the rotating member is fixed to the shaft and has no springs. The stationary member is spring-loaded, which is an effective way of overcoming potential angular mis-alignment problems. In addition very large clearances have been provided between the rotary and stationary members and the gland halves, which should minimize dead-ending or solidification problems that could be present in a stationary seal that had minimal clearances, particularly around the outside diameter of the stationary.

RDS™ - Radially Divided Seal

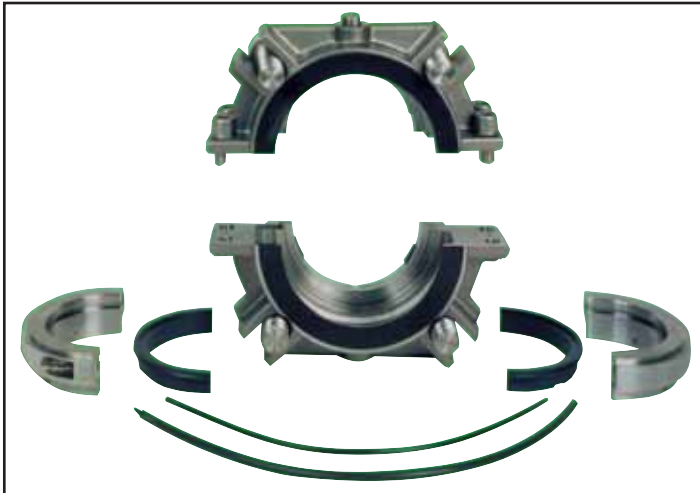

Design Concept

The most important single objective was to design a radially divided seal that was easy to install. This was achieved by having the smallest possible number of parts to assemble.

The entire seal assembly comprises of only three 'O' rings, two rotary halves, two stationary halves and two gland cartridge halves, which include the springs and spring retainer. The only other parts are socket set screws and Allen keys.

A pre-assembled patented spring retainer ensures the springs are not under compression during the initial assembly. All seal parts are assembled, fixed to the shaft and tightened, before loading the springs, which are only compressed when the seal assembly is bolted to the face of the stuffing box.

Performance

Extensive in-house testing, the most extensive testing ever undertaken for any product developed by the Company, has enabled us to set the following performance parameters.

The PV (Pressure times Velocity) capability of the seal is being rated at 80 bar meters a second, which is 230,000 pounds per square inch/feet per minute.

Actual tests have been successfully completed at PV ratings of 340,000 pounds per square inch/feet per minute (120 bar meters a second) with a reduced life expectancy.

A chart follows which shows typical PV values, at a range of pressures, shaft diameters and at two different rotating speeds.



Small Diameter Test Rig with 3.750" (95mm) RDS™ Installed.

The elastomer seals for both the rotary face and gland assembly have been designed to simplify installation.

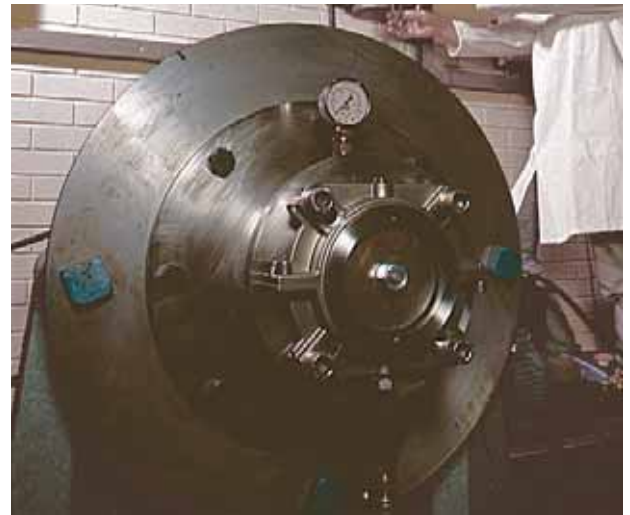

Dynamic Test Rig with 5.000" (125mm) RDS™ Installed. (Capacity 8.000" (200mm) Shaft Diameter).

Calculated PV Factors				
Shaft Size	Pressure (bar/psi)	Speed (rpm)	Factor (bar/m/s)	Factor (lbs/in2ft/min)
1.000 (25mm)	4/60	1450	7.7	22000
	10/150	1450	19.3	55000
	4/60	2850	15.1	43000
1.000 (25mm)	10/150	2850	37.9	108000
	4/60	1450	15.4	44000
	10/150	1450	38.6	110000
2.000 (50mm)	4/60	2850	30.2	86000
	10/150	2850	75.8	216000
	4/60	1450	23.1	66000
4.000 (100mm)	10/150	1450	57.9	165000
	4/60	2850	45.3	129000
	4/60	1450	30.3	86000
5.000 (125mm)	10/150	1450	77.2	220000
	4/60	2850	60.4	172000
	4/60	1450	38.5	110000
5.000+ (125mm+)	8/120	1450	77.2	220000
	4/60	2850	75.5	216000
	Consult AESSEAL®			
(Maximum is 80 bar m/s (230,000 psi ft/min))				

Application Area

As with all radially divided seals, the ideal application area is in cool, clean fluids, which are non-hazardous and with minimal corrosive potential.

Such applications exist within every industry even though the RDS™ seal is not suitable for sealing even a majority of applications in most plants.

Where no emissions or leakage, even on an occasional basis, can be tolerated, our radially divided mechanical seal should not be installed.



RDS™ - Radially Divided Seal

Installation and Wear Indicator

A stationary anti-rotation pin is also designed as an indicator that the RDS™ seal has been properly installed, before pressurizing and running the equipment.

An undercut in the pin should fall equally in the seal setting groove, if the seal is fitted to the correct working length.

The end of the pin will also move progressively towards the RDS™ gland as wear takes place, providing an indication of the remaining seal life. When the end of the pin is level with the gland, the RDS™ seal face replacement kit should be installed.

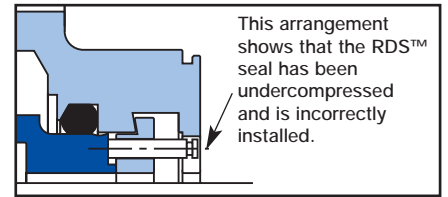
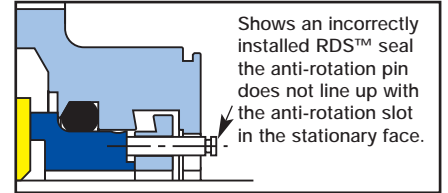
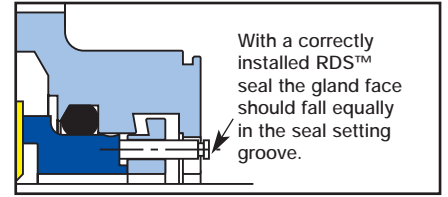
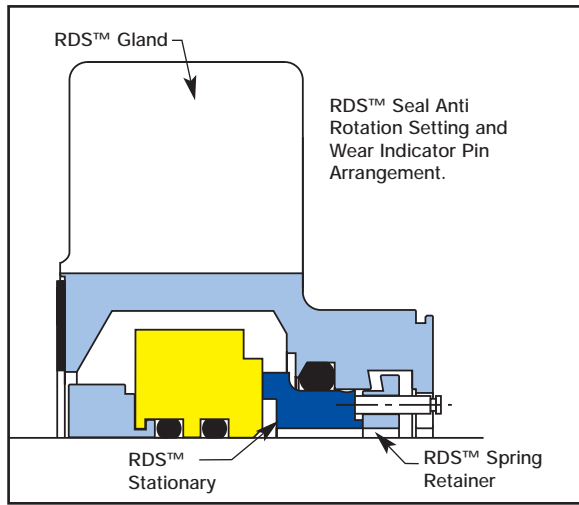

Gland Half Location & Bolting Detail

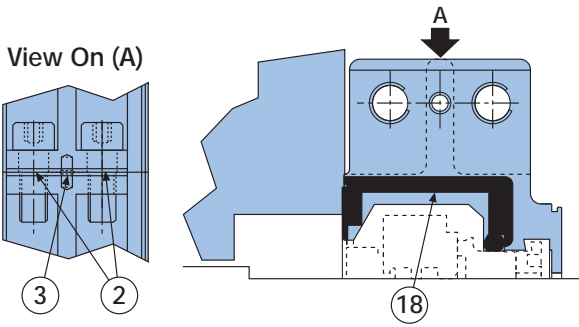

Gland Bolting Detail

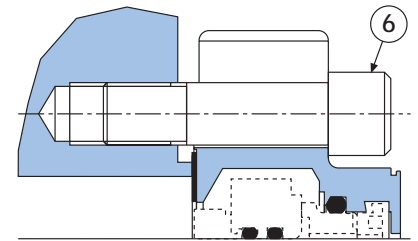

Seal General Assembly

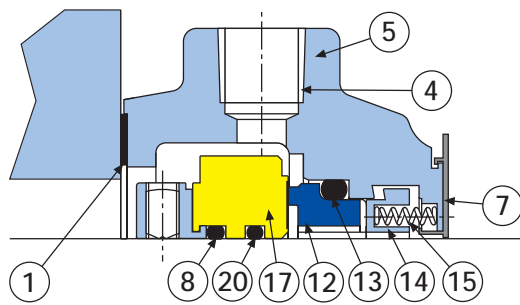

View On (B)

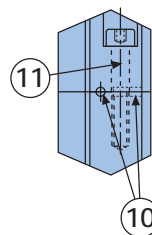

Rotary Location / Clamping

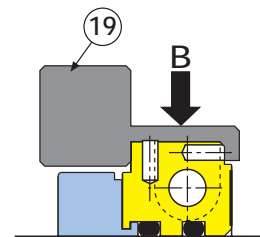

Item	Description	Material	Item	Description	Material
1	Gasket	Viton® / Aflas®*	11	Rotary Cap Head	316 Stainless Steel
2	Cap Head Screws	316 Stainless Steel	12	Stationary Face	Carbon
3	Gland Dowels	316 Stainless Steel	13	Stationary O Ring	Viton® / Aflas®*
4	Flush Port	n/a	14	Spring Retainer	316L SS
5	RDS™ Gland	316 Stainless Steel	15	Springs	Hastelloy® C
6	Gland Bolt	Not Supplied	16	Anti Rotation Pin	316 Stainless Steel
7	Centering Clips	Plastic	17	Solid Rotary Face	316L SS/CH.Ox
8	Shaft O Ring	Viton® / Aflas®*	18	Gland U-Gasket	Viton® / Aflas®*
9	Drive Screw	316 Stainless Steel	19	Rotary Face Clip	Plastic
10	Rotary Dowel	316 Stainless Steel	20	Shaft O Ring	Viton® / Aflas®*

* Aflas is only available upto and including 8.000" (200mm).

RDS™ - Dimensional Information (inches)

2.500" - 2.625" RDS™ seal from -21 casting

	DIM A	DIM B	DIM C	DIM D	DIM E	DIM F	DIM G	DIM H	DIM I	MAXIMUM BOLT DIA
S	2.500	3.750	4.250	5.125	6.500	1.938	1.750	0.818	1.120	0.625
S	2.625	3.750	4.250	5.125	6.500	1.938	1.750	0.818	1.120	0.625

2.625" - 2.750" RDS™ seal from -22 casting

S	2.625	4.250	4.750	5.687	7.750	2.500	1.750	0.818	1.120	0.625
S	2.750	4.250	4.750	5.687	7.750	2.500	1.750	0.818	1.120	0.625

2.500" - 3.000" RDS™ seal from -24/21 casting

Z	2.500 TO 2.750	4.500	5.000	5.937	8.000	2.500	1.750	0.818	1.120	0.625
S	2.875	4.500	5.000	5.937	8.000	2.500	1.750	0.818	1.120	0.625
S	3.000	4.500	5.000	5.937	8.000	2.500	1.750	0.818	1.120	0.625

2.500" - 3.250" RDS™ seal from -26/20 casting

Z	2.500 TO 3.000	4.750	5.250	6.250	8.250	2.500	1.750	0.818	1.120	0.625
S	3.125	4.750	5.250	6.250	8.250	2.500	1.750	0.818	1.120	0.625
S	3.250	4.750	5.250	6.250	8.250	2.500	1.750	0.818	1.120	0.625

2.625" - 3.500" RDS™ seal from -28/22 casting

Z	2.625 TO 3.250	5.000	5.500	6.562	8.500	2.500	1.750	0.818	1.120	0.750
S	3.375	5.000	5.500	6.562	8.500	2.500	1.750	0.818	1.120	0.750
S	3.500	5.000	5.500	6.562	8.500	2.500	1.750	0.818	1.120	0.750

2.875" - 3.750" RDS™ seal from -30/24 casting

Z	2.875 TO 3.500	5.250	5.750	6.750	8.750	2.500	1.750	0.818	1.120	0.750
S	3.625	5.250	5.750	6.750	8.750	2.500	1.750	0.818	1.120	0.750
S	3.750	5.250	5.750	6.750	8.750	2.500	1.750	0.818	1.120	0.750

3.125" - 4.000" RDS™ seal from -32/26 casting

Z	3.125 TO 3.750	5.500	6.000	7.062	9.000	2.500	1.750	0.818	1.120	0.750
S	3.875	5.500	6.000	7.062	9.000	2.500	1.750	0.818	1.120	0.750
S	4.000	5.500	6.000	7.062	9.000	2.500	1.750	0.818	1.120	0.750

3.625" - 4.500" RDS™ seal from -36/30 casting

Z	3.625 TO 4.250	6.000	6.500	7.562	9.500	2.500	1.750	0.818	1.120	0.750
S	4.375	6.000	6.500	7.562	9.500	2.500	1.750	0.818	1.120	0.750
S	4.500	6.000	6.500	7.562	9.500	2.500	1.750	0.818	1.120	0.750

4.125" - 5.125" RDS™ seal from -40/34 casting

Z	4.125 TO 4.750	6.500	7.000	8.062	11.000	2.500	1.750	0.818	1.120	0.750
S	4.875	6.500	7.000	8.062	11.000	2.500	1.750	0.818	1.120	0.750
S	5.000	6.500	7.000	8.062	11.000	2.500	1.750	0.818	1.120	0.750
Z	5.125	6.500	7.000	8.062	11.000	2.500	1.750	1.025	1.397	0.750

5.250" - 5.500" RDS™ seal from -44 casting

S	5.250	7.500	8.000	9.000	11.750	3.187	2.375	1.025	1.397	1.000
S	5.500	7.500	8.000	9.000	11.750	3.187	2.375	1.025	1.397	1.000

5.750" - 6.000" RDS™ seal from -48 casting

S	5.750	8.000	8.500	9.500	12.250	3.187	2.375	1.025	1.397	1.000
S	6.000	8.000	8.500	9.500	12.250	3.187	2.375	1.025	1.397	1.000

6.250" - 6.500" RDS™ seal from -52 casting

S	6.250	8.500	9.000	9.875	12.750	3.187	2.375	1.025	1.397	1.000
S	6.500	8.500	9.000	9.875	12.750	3.187	2.375	1.025	1.397	1.000

6.750" - 7.000" RDS™ seal from -56 casting

S	6.750	9.000	9.500	10.500	13.250	3.437	2.625	1.025	1.397	1.000
S	7.000	9.000	9.500	10.500	13.250	3.437	2.625	1.091	1.647	1.000

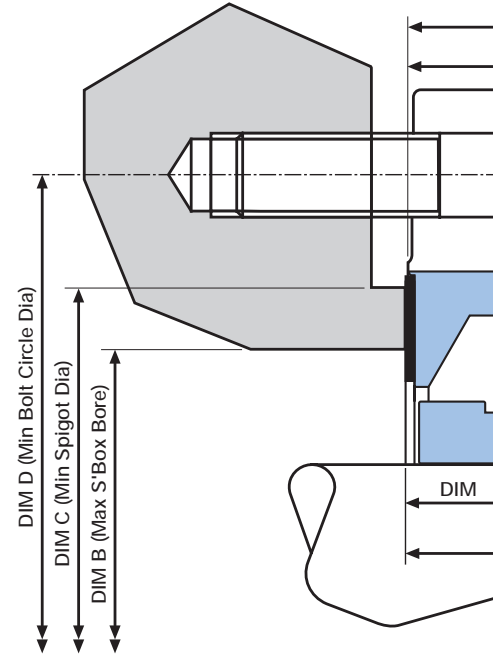

- Minimum parts to assemble
- Separation technology - precision lapped (not cracked) rotary faces
- PATENTED assembled spring retainer (springs cannot fall out)
- External, visible, indicator of correct installation

'S' SIGNIFIES PLANNED INVENTORY ITEMS
'Z' SIGNIFIES GLANDS MACHINED TO ORDER

RDS™ - Dimensional Information (mm)

63mm - 65mm RDS™ seal from -21 casting

	DIM A	DIM B	DIM C	DIM D	DIM E	DIM F	DIM G	DIM H	DIM I	MAXIMUM BOLT DIA
Z	63.0	95.3	108.0	130.2	165.1	49.3	44.5	20.7	28.4	16.0
Z	65.0	95.3	108.0	130.2	165.1	49.3	44.5	20.7	28.4	16.0

65mm - 70mm RDS™ seal from -22 casting

S	65	108.0	120.7	144.4	196.9	63.5	44.5	20.7	28.4	16.0
S	70	108.0	120.7	144.4	196.9	63.5	44.5	20.7	28.4	16.0

65mm - 75mm RDS™ seal from -24/21 casting

Z	65	114.3	127.0	150.8	203.2	63.5	44.5	20.7	28.4	16.0
Z	70	114.3	127.0	150.8	203.2	63.5	44.5	20.7	28.4	16.0
S	75	114.3	127.0	150.8	203.2	63.5	44.5	20.7	28.4	16.0

65mm - 80mm RDS™ seal from -26/20 casting

Z	65 TO 75	120.7	133.4	158.8	209.6	63.5	44.5	20.7	28.4	16.0
S	80	120.7	133.4	158.8	209.6	63.5	44.5	20.7	28.4	16.0

65mm - 85mm RDS™ seal from -28/22 casting

Z	65 TO 80	127.0	139.7	166.7	215.9	63.5	44.5	20.7	28.4	20.0
S	85	127.0	139.7	166.7	215.9	63.5	44.5	20.7	28.4	20.0

75mm - 95mm RDS™ seal from -30/24 casting

Z	75 TO 85	133.4	146.1	171.5	222.3	63.5	44.5	20.7	28.4	20.0
S	90	133.4	146.1	171.5	222.3	63.5	44.5	20.7	28.4	20.0
S	95	133.4	146.1	171.5	222.3	63.5	44.5	20.7	28.4	20.0

80mm - 100mm RDS™ seal from -32/26 casting

Z	80 TO 95	139.7	152.4	179.4	228.6	63.5	44.5	20.7	28.4	20.0
S	100	139.7	152.4	179.4	228.6	63.5	44.5	20.7	28.4	20.0

90mm - 110mm RDS™ seal from -36/30 casting

Z	90 TO 105	152.4	165.1	192.1	241.3	63.5	44.5	20.7	28.4	20.0
S	110	152.4	165.1	192.1	241.3	63.5	44.5	20.7	28.4	20.0

105mm - 130mm RDS™ seal from -40/34 casting

Z	105 TO 120	165.1	177.8	204.8	279.4	63.5	44.5	20.7	28.4	20.0
S	125	165.1	177.8	204.8	279.4	63.5	44.5	20.7	28.4	20.0
S	130	165.1	177.8	204.8	279.4	63.5	44.5	26.0	35.5	20.0

140mm - RDS™ seal from -44 casting

S	140.0	190.5	203.2	228.6	298.4	80.9	60.3	26.0	35.5	25.0
---	-------	-------	-------	-------	-------	------	------	------	------	------

145mm - 150mm RDS™ seal from -48 casting

S	145.0	203.2	215.9	241.3	311.1	80.9	60.3	26.0	35.5	25.0
S	150.0	203.2	215.9	241.3	311.1	80.9	60.3	26.0	35.5	25.0

160mm - 165mm RDS™ seal from -52 casting

S	160.0	215.9	228.6	254.0	323.8	80.9	60.3	26.0	35.5	25.0
S	165.0	215.9	228.6	254.0	323.8	80.9	60.3	26.0	35.5	25.0

170mm - 175mm RDS™ seal from -56 casting

S	170.0	228.6	241.3	266.7	336.5	87.3	66.7	26.0	35.5	25.0
S	175.0	228.6	241.3	266.7	336.5	87.3	66.7	26.0	35.5	25.0

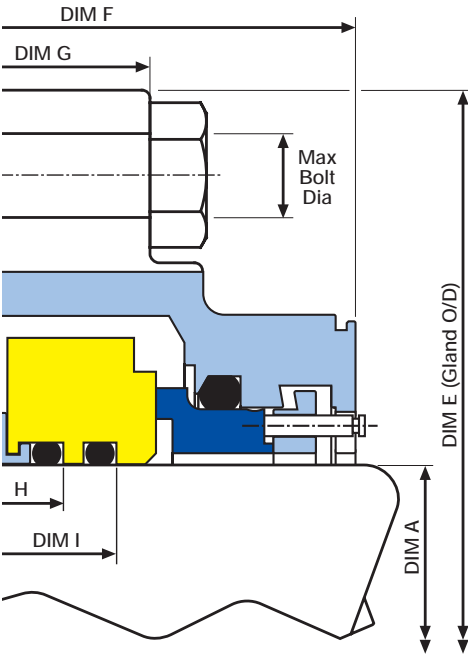

- External, visible, life indicator pin (to assist preventative maintenance)
- Balanced stationary design with large internal clearances
- Unique 'O' ring design (for predictable easy joining and assembly)
- By design gland studs or socket screws do not add to the installed length

'S' SIGNIFIES PLANNED INVENTORY ITEMS
'Z' SIGNIFIES GLANDS MACHINED TO ORDER

RDS™ - Dimensional Information

RDS™ - Dimensional Information (inches)

7.250" - 7.500" RDS™ seal from -60 casting

DIM A	DIM B	DIM C	DIM D	DIM E	DIM F	DIM G	DIM H	DIM I	BOLT DIA	MAXIMUM
7.250	9.500	10.000	11.000	13.750	3.437	2.625	1.091	1.647	1.000	
7.500	9.500	10.000	11.000	13.750	3.437	2.625	1.091	1.647	1.000	

7.750" - 8.000" RDS™ seal from -64 casting

DIM A	DIM B	DIM C	DIM D	DIM E	DIM F	DIM G	DIM H	DIM I	BOLT DIA	MAXIMUM
7.750	10.250	11.000	12.250	16.000	3.660	3.187	1.091	1.647	1.000	
8.000	10.250	11.000	12.250	16.000	3.660	3.187	1.091	1.647	1.000	

8.250" - 8.500" RDS™ seal from -68 casting

DIM A	DIM B	DIM C	DIM D	DIM E	DIM F	DIM G	DIM H	DIM I	BOLT DIA	MAXIMUM
8.250	10.750	11.500	12.750	16.500	3.660	3.187	1.287	1.711	1.000	
8.500	10.750	11.500	12.750	16.500	3.660	3.187	1.287	1.711	1.000	

8.750" - 9.000" RDS™ seal from -72 casting

DIM A	DIM B	DIM C	DIM D	DIM E	DIM F	DIM G	DIM H	DIM I	BOLT DIA	MAXIMUM
8.750	11.250	12.000	13.250	17.000	3.660	3.187	1.287	1.711	1.000	
9.000	11.250	12.000	13.250	17.000	3.660	3.187	1.287	1.711	1.000	

9.250" - 9.500" RDS™ seal from -76 casting

DIM A	DIM B	DIM C	DIM D	DIM E	DIM F	DIM G	DIM H	DIM I	BOLT DIA	MAXIMUM
9.250	11.750	12.500	13.750	17.500	3.660	3.187	1.287	1.711	1.000	
9.500	11.750	12.500	13.750	17.500	3.660	3.187	1.287	1.711	1.000	

9.625" - 10.000" RDS™ seal from -80 casting

DIM A	DIM B	DIM C	DIM D	DIM E	DIM F	DIM G	DIM H	DIM I	BOLT DIA	MAXIMUM
9.625	12.250	13.000	14.250	18.000	3.875	3.187	1.287	1.711	1.000	
9.750	12.250	13.000	14.250	18.000	3.875	3.187	1.287	1.711	1.000	
10.000	12.250	13.000	14.250	18.000	3.875	3.187	1.287	1.711	1.000	

10.250" - 10.500" RDS™ seal from -84 casting

DIM A	DIM B	DIM C	DIM D	DIM E	DIM F	DIM G	DIM H	DIM I	BOLT DIA	MAXIMUM
10.250	12.750	13.500	14.750	18.500	3.875	3.187	1.287	1.711	1.000	
10.500	12.750	13.500	14.750	18.500	3.875	3.187	1.287	1.711	1.000	

10.750" - 11.000" RDS™ seal from -88 casting

DIM A	DIM B	DIM C	DIM D	DIM E	DIM F	DIM G	DIM H	DIM I	BOLT DIA	MAXIMUM
10.750	13.250	14.000	15.250	19.000	3.875	3.187	1.287	1.711	1.000	
11.000	13.250	14.000	15.250	19.000	3.875	3.187	1.287	1.711	1.000	

11.250" - 11.500" RDS™ seal from -92 casting

DIM A	DIM B	DIM C	DIM D	DIM E	DIM F	DIM G	DIM H	DIM I	BOLT DIA	MAXIMUM
11.250	13.750	14.500	15.750	19.500	3.875	3.187	1.287	1.711	1.000	
11.500	13.750	14.500	15.750	19.500	3.875	3.187	1.287	1.711	1.000	

11.750" - 12.000" RDS™ seal from -96 casting

DIM A	DIM B	DIM C	DIM D	DIM E	DIM F	DIM G	DIM H	DIM I	BOLT DIA	MAXIMUM
11.750	14.250	15.000	16.250	20.000	3.875	3.187	1.287	1.711	1.000	
12.000	14.250	15.000	16.250	20.000	3.875	3.187	1.287	1.711	1.000	



WARNING

MAXIMUM P.V. RATING IS 80 BAR M/S
(230,000 PSI FT/MIN)

RDS™ - Dimensional Information (mm)

180mm - 190mm RDS™ seal from -60 casting

DIM A	DIM B	DIM C	DIM D	DIM E	DIM F	DIM G	DIM H	DIM I	BOLT DIA	MAXIMUM
180.0	241.3	254.0	279.4	349.2	87.3	66.7	27.7	41.8	25.0	
190.0	241.3	254.0	279.4	349.2	87.3	66.7	27.7	41.8	25.0	

200mm - 205mm RDS™ seal from -64 casting

DIM A	DIM B	DIM C	DIM D	DIM E	DIM F	DIM G	DIM H	DIM I	BOLT DIA	MAXIMUM
200	260.4	275.4	311.2	406.4	93.0	81.0	27.7	41.8	24.0	
205	260.4	275.4	311.2	406.4	93.0	81.0	32.7	43.5	24.0	

210mm - 215mm RDS™ seal from -68 casting

DIM A	DIM B	DIM C	DIM D	DIM E	DIM F	DIM G	DIM H	DIM I	BOLT DIA	MAXIMUM
210	273.0	292.1	323.9	419.1	93.0	81.0	32.7	43.5	24.0	
215	273.0	292.1	323.9	419.1	93.0	81.0	32.7	43.5	24.0	

220mm - 225mm RDS™ seal from -72 casting

DIM A	DIM B	DIM C	DIM D	DIM E	DIM F	DIM G	DIM H	DIM I	BOLT DIA	MAXIMUM
220	285.8	304.8	336.6	431.8	93.0	81.0	32.7	43.5	24.0	
225	285.8	304.8	336.6	431.8	93.0	81.0	32.7	43.5	24.0	

230mm - 240mm RDS™ seal from -76 casting

DIM A	DIM B	DIM C	DIM D	DIM E	DIM F	DIM G	DIM H	DIM I	BOLT DIA	MAXIMUM
230	298.5	317.5	349.3	444.5	93.0	81.0	32.7	43.5	24.0	
240	298.5	317.5	349.3	444.5	93.0	81.0	32.7	43.5	24.0	

245mm - 255mm RDS™ seal from -80 casting

DIM A	DIM B	DIM C	DIM D	DIM E	DIM F	DIM G	DIM H	DIM I	BOLT DIA	MAXIMUM
245	311	330.2	361.9	457.2	98.4	81.0	32.7	43.5	24.0	
250	311	330.2	361.9	457.2	98.4	81.0	32.7	43.5	24.0	
255	311	330.2	361.9	457.2	98.4	81.0	32.7	43.5	24.0	

260mm - 265mm RDS™ seal from -84 casting

DIM A	DIM B	DIM C	DIM D	DIM E	DIM F	DIM G	DIM H	DIM I	BOLT DIA	MAXIMUM
260	323.8	342.9	374.6	469.9	98.4	81.0	32.7	43.5	24.0	
265	323.8	342.9	374.6	469.9	98.4	81.0	32.7	43.5	24.0	

270mm - 280mm RDS™ seal from -88 casting

DIM A	DIM B	DIM C	DIM D	DIM E	DIM F	DIM G	DIM H	DIM I	BOLT DIA	MAXIMUM
270	336.5	355.6	387.3	482.6	98.4	81.0	32.7	43.5	24.0	
280	336.5	355.6	387.3	482.6	98.4	81.0	32.7	43.5	24.0	

285mm - 290mm RDS™ seal from -92 casting

DIM A	DIM B	DIM C	DIM D	DIM E	DIM F	DIM G	DIM H	DIM I	BOLT DIA	MAXIMUM
285	349.2	368.3	400.0	495.3	98.4	81.0	32.7	43.5	24.0	
290	349.2	368.3	400.0	495.3	98.4	81.0	32.7	43.5	24.0	

295mm - 305mm RDS™ seal from -96 casting

DIM A	DIM B	DIM C	DIM D	DIM E	DIM F	DIM G	DIM H	DIM I	BOLT DIA	MAXIMUM
295	361.9	381.0	412.7	508.0	98.4	81.0	32.7	43.5	24.0	
305	361.9	381.0	412.7	508.0	98.4	81.0	32.7	43.5	24.0	

NOT ALL SIZES INVENTORIED - CONSULT AESSEAL® FOR AVAILABILITY.

FOR DETAILS ON SIZES NOT SHOWN CONTACT AESSEAL® FOR FURTHER INFORMATION.

THIS DOCUMENT IS DESIGNED TO PROVIDE DIMENSIONAL INFORMATION AND AN INDICATION OF AVAILABILITY. FOR FURTHER INFORMATION AND SAFE OPERATING LIMITS CONTACT OUR TECHNICAL SPECIALISTS AT THE LOCATIONS BELOW.



USE DOUBLE MECHANICAL SEALS WITH HAZARDOUS PRODUCTS. ALWAYS TAKE SAFETY PRECAUTIONS:

- GUARD YOUR EQUIPMENT
- WEAR PROTECTIVE CLOTHING



UK Sales & Technical advice:

AESSEAL plc
Mill Close
Templeborough
Rotherham
S60 1BZ
United Kingdom

Telephone: +44 (0) 1709 369966
Fax: +44 (0) 1709 720788
E-mail: seals@aes seal.com
Internet: http://www.aes seal.com

POLYFLON®

Handelsgesellschaft m. b. H.

YOUR POINT OF CONTACT FOR SEALING APPLICATIONS!

8020 Graz
Baumkircherstraße 3
Tel.: +43(0)316/71 10 89
Fax: +43(0)316/71 89 55
www.polyflon.at



2371 Hinterbrühl
Gadnerstraße 36b
Tel.: +43(0)2236/26 718
Fax: +43(0)2236/46 811
office@polyflon.at

USA Sales & Technical advice:

AESSEAL Inc.
355 Dunavant Drive
Rockford, TN. 37853
USA

Telephone: +1 865 531 0192
Fax: +1 865 531 0571
E-mail: usa@aes seal.com

ALL SIZES ARE SUBJECT TO MANUFACTURING TOLERANCES. WE RESERVE THE RIGHT TO MODIFY SPECIFICATIONS AT ANY TIME.